

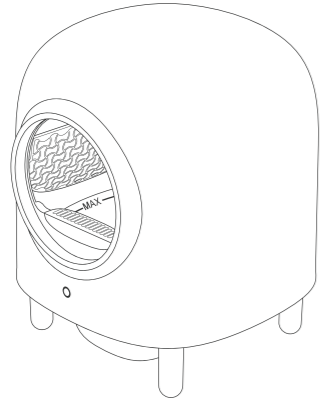

Automatic Cat Litter Box Instruction



Please read the operation manual carefully and keep it properly before using the product

Product List

Please carefully check the product list quantity

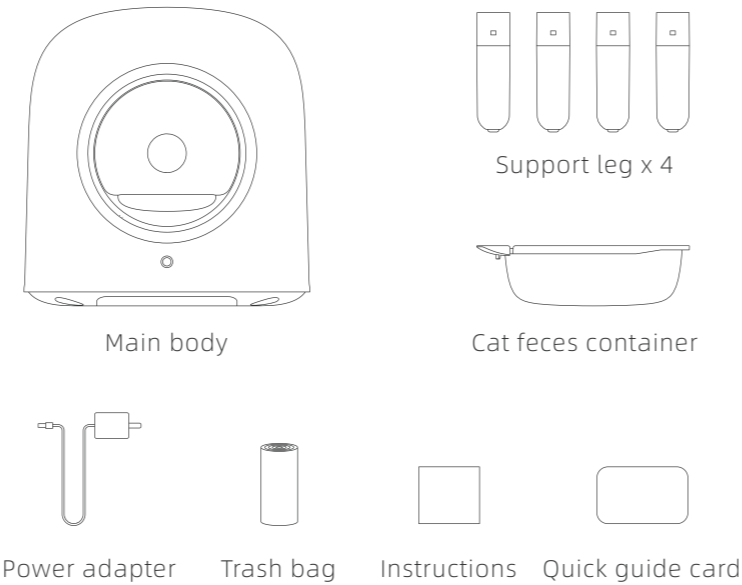

Installation Instructions

1. Take the outer cover, take the ball compartment

Take out the main body, remove the cover, open the lock ball and scribe, remove the ball compartment, and get the base.

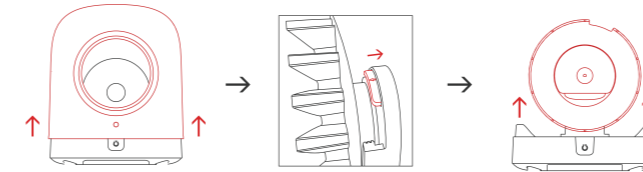

2. Put the base diagonally and install the support legs

Place the base of the main body on the side and install 4 support legs, After the installation is complete.

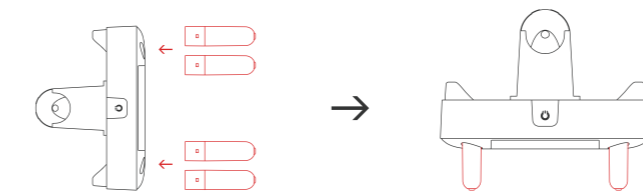

5. Power on and wait for device self-test

Turn on the power and wait for the completion of the self-check operation of the device (the white light is always on after the self-check is completed).

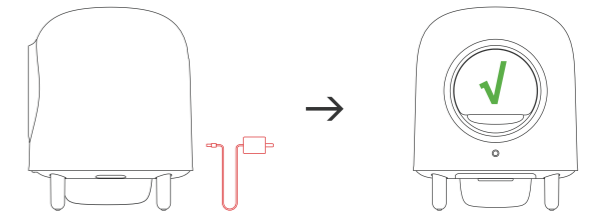

6. Add cat litter

Add clumping cat litter from the hole. Do not add more cat litter than the MAX cat litter line. After adding the litter, click the button on the main body and wait for the end of the run to be used normally

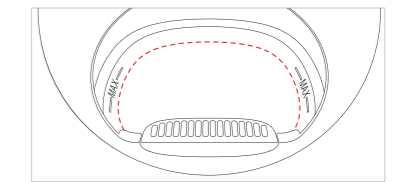

Statement

Thank you for purchasing the Petree smart cat litter box. Beiqu Technology is committed to making your pet life better through the power of design. This instruction will help you better understand and use this product.

User Notice

1. Please install and use this product according to the instructions
2. This device needs to be placed on a level ground
3. No items are allowed on the top of the device
4. Don't use in a high temperature and high humidity environment
5. Don't use non-clumping cat litter
6. Don't place foreign objects in the ball room
7. Don't force the cat into the ball room
8. The automatic mode of the device is not suitable for cats younger than 6 months
9. The base part is forbidden to wash

Product Introduction

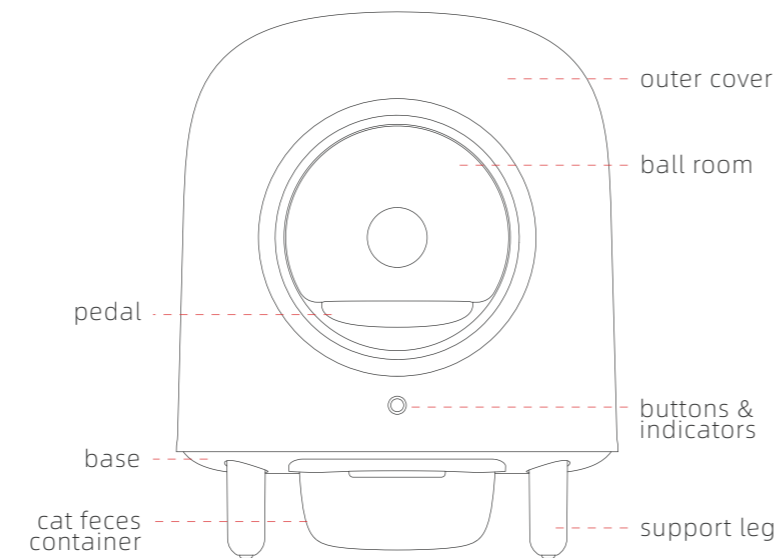

3. Install the ball compartment, install the outer cover

Put the ball compartment back on the base, close the lock ball and scribe, and finally put on the outer cover.

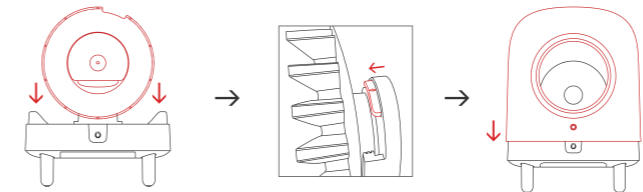

4. Install trash bag & deodorant box

Take out the inner hoop of the cat feces container, install the deodorizing box (purchased separately), and return it after putting the garbage bag in the cat feces container to ensure that the garbage bag is not excessively upturned, then put it back into the main body

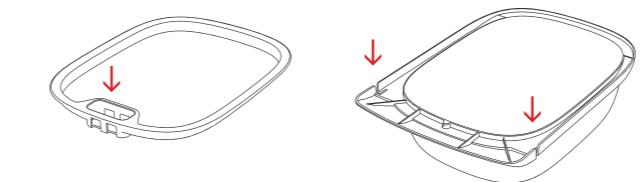

7. Distribution network

Scan the code to download the APP, press and hold the host button, and enter the network configuration state after a long beep (please place the device in a WiFi coverage environment), open the APP, follow the APP instructions to add the device and connect to the network.



Scan code to download APP

Distribution network precautions

1. The litter box only supports 2.4G WiFi, not 5G WiFi
2. The mobile phone needs to turn on Bluetooth when configuring the network
3. If the APP cannot find the device, please power off the device for 5 seconds and then restart it
4. Only one account can be added to a device, and the device can be shared with other users in the APP
5. If the power is interrupted during operation, it will automatically return to the horizontal position after power on

Button and light description

main body button	single press	start/pause/continue	clean function
		pause/continue	empty litter function
	double press	start up	dumping cat litter function
	long press for 3 seconds	running status	cancel the running function
standby state		enter the distribution mode	

indicator light	white light	fast flashing	paired network mode or program upgrading
		slow flashing	cleaning mode or sand dumping mode is running
		breathing changes	turn on do not disturb
		always on	standby state
	red light	slow flashing	triggered the sensor
			the cover is not placed
	always on	cat feces container full	

Function Description

1. Automatic cleaning function

After the cat leaves the toilet, the machine starts cleaning 3 minutes later. If the cat enters during operation, the machine will stop and continues to operate after the cat leaves

2. Device information push function

When the machine is connected to WiFi and added to the app the current status information of the machine will be pushed to the app in real time.

3. Dumping cat litter function

Double click the host button or click the sand dumping button on the app, if the cat enters during operation, the equipment will stop and continue to run after the cat leaves

4. Smart deodorizing function

Smart deodorization is always on by default under normal conditions. In the "mode" button of app, the "automatic deodorization" function can be turned off

5. Do not disturb mode function

Click the "do not disturb mode" button in the app, and the equipment will enter the mode at the corresponding time every day without any operation

Common problems and Solutions

1. How old cats can use the device?

The automatic function of this product is applicable to cats over 4 months old and weighing more than 1kg. If the cat's weight or age does not meet the standard, do not use the automatic excrement removal function. You can choose to turn on the device in the do not disturb mode for 24 hours and manually turn on the excrement removal function

2. What if the cat doesn't want to use the new litter box?

If the cat has strong vigilance, can place machine next to the old litter box for a period of time, and put some old litter with the smell of the cat into the new equipment. The familiar smell will also make the cat more easy to adapt

3. Is it dangerous for cats to enter when the ball rotates?

If a cat enters the ball bin when it rotates, the monitoring sensor will be triggered immediately, the ball room will stop rotating immediately, and the equipment will continue to operate after the cat leaves the ball room for a period of time. Therefore, there is no need to worry that the cat will enter the running ball room

4. What types of cat litter can I use?

This product supports most agglomerated cat litter (tofu sand, mixed sand, etc.) Do not use non agglomerated or poorly agglomerated sand (crystal sand, wood-based sand, etc.)

5. How much cat litter should I add?

It's recommended to add about 4L cat litter for the first time. Do not exceed the max sand level line. Excess sand will be filtered into the cat feces container during operation

6. When should I replenish cat litter?

It can be determined according to the specific use situation. It's recommended to supplement cat litter when the remaining half of the cat litter is used

7. How often does it take to clean the cat feces container?

It can be determined according to the specific use situation (factors such as the number of cats) It's recommended to replace it once every 3~5 days in the case of one cat (the frequency needs to be increased in hot weather)

8. How often does it take to clean the ball room?

It can be determined according to the specific use conditions (number of cats or defecation status of cats, etc.) it's recommended to wash once every 1~3 months if it's possible

Cleaning Instruction

1. Remove residual litter

Double click the host button (or click the "sand dumping" button on the app) to start the sand dumping function (too much residual sand may trigger the prompt that the toilet bin is full. Shaking the toilet bin can reduce the risk of cat litter scattering)

2. Disassembly and Cleaning

Take down the cat feces container, take down the cover, open the ball room scribe and take down the ball room

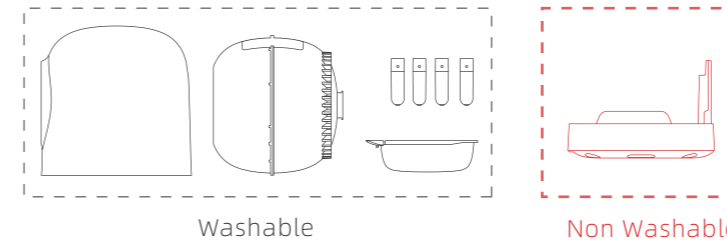

3. Dry and Assemble

After the cleaning is completed and the machine is dried, install the ball room, cover and cat feces container in turn. If the red light flashes after the installation is powered on, check whether the cover is installed in place

Quick troubleshooting

1. Shortly after turn on, the "drip sound" of the equipment will sound for a short time and flash with the red light

Try to readjust the position of the cover.

2. The machine stops suddenly during operation, and the red light flashes

The machine senses the entry of objects into and starts the pause program. After the delay, it will resume operation. (when the agglomerate is too large or the rolling speed is too fast, it may also trigger the stop)

3. The red light of the machine is always on, and the cleaning program cannot be started

Check whether the trash box is full.

4. During sand dumping, the machine stops and the red light is always on

If the amount of residual sand is too large, resulting in the trash box full, shake the cat feces container back and forth to smooth the residual sand or dump it twice (it needs to be started manually after stopping, so there is no need to worry about dumping the remaining cat litter automatically)

Description of hazardous substances

Part	Hazardous substances					
	Pb	Hg	Cd	Cr(VI)	PBB	PBDE
Cover	○	○	○	○	○	○
PCBA	×	○	○	○	○	○
Wire	×	○	○	○	○	○
Metal	×	○	×	○	○	○
Adapter	×	○	×	○	○	○

○: Indicates that the content of the hazardous substance in all homogeneous materials of the component is below the limit specified in GB / T 26572.
 ×: Indicates that the content of the hazardous substance in at least one homogeneous material of the component exceeds the limit specified in GB / T 26572.

Product Parameters

Name: Automatic Cat Litter Box

Type: ACC-21-02/ACC-21-03

N.W.: 10KG **Product Size:** 520 x 520 x 640 (mm)

Standard: GB4706.1-2005 **Rated voltage:** 12V \pm 1A

Company: Hangzhou Beiqu Technology Co., Ltd

Address: 1-306 Jinsha Lake Commercial Center, Qiantang New District, Hangzhou, Zhejiang

Wi-Fi frequency range: 2.400~2.4835GHz

Maximum Wi-Fi transmit power: 18dBm

After-sale service

Warranty

- When the customer purchases the machine, the warranty card is attached to the manual, which shall be properly kept as the warranty certificate after being filled in by the user
- If the product has quality problems within 12 months from the date of purchase, it shall be approved by the company. After verification, consumers enjoy free maintenance service (except power adapter)

Non warranty description

- Those including but not limited to the following circumstances are not within the scope of three guarantees
- It has exceeded the validity period of the Guarantees service
 - Dismantle the machine without permission
 - Damage caused by human or irresistible factors
 - Damage caused by failure to use or maintain in accordance with the requirements of this manual
 - Aging during normal use of the product
 - Accessories and gifts

