

CV-Laser Module User manual

激光模组用户使用手册

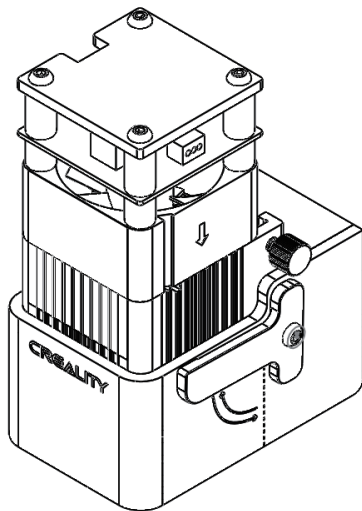

Thank you for choosing our products. For the best experience, please read the instructions before operating the product. Our teams will always be ready to render you the best services. Please contact us via the phone number or e-mail address provided at the end when you encounter any problem.

Visit our official website www.creality.com to find relevant software/hardware information, contact details and operation and maintenance instructions.

尊敬的用户：

感谢您选择创想三维的产品。为了您使用方便，请您在使用之前仔细阅读本说明书，并严格按照说明书的指示进行操作。创想三维团队时刻准备为您提供优质的服务。在使用过程中无论遇到什么问题，请按照说明书结尾所提供的电话、邮箱与我们进行联系。

您还可以登陆创想三维官网(www.cxsw3d.com)寻找相关软硬件、联系方式、设备操作、设备保养等信息。

For a better experience in using our product, you can also learn how to use the Printer in the following ways:
为了您能够更好的体验我们的产品，你还可以从以下方式获取设备操作知识：

国内：<https://www.crealitycloud.cn/post-detail/7657> (CV-Laser Module的安装与应用)

Overseas：<https://www.crealitycloud.com/post-detail/8672> (CV-Laser Module Installation And Application)



Scan QR code to watch installation videos
扫描二维码观看产品安装视频

Using the high-density laser beam to heat up the workpiece surface when engraving or cutting aims to gasify without combustion. While most workpieces are essentially combustible, which may be ignited, leading to open fire and consequently to the machine breakdown and environmental contamination. Please follow the following operating principles.

- 1 It is prohibited to store the machine in areas close to combustible and explosive substances, volatile solvents or source of heat. Instead, store it in a well-ventilated, cool and dust-free place;
- 2 Make sure that only the specific attached power cord rather than other similar power cords are used during installation;
- 3 Do regular maintenance. Clean the product with a dry cloth when the power is turned off, wiping away dust and foreign matter;
- 4 Ensure to run the laser at 0°C-35°C. Operation at sub-zero temperature is prohibited;
- 5 Switch off the machine if it is offline for an extended period of time, and unplug the power cord; It is prohibited to run the machine under wet environment or in thunderstorm weather;
- 6 It is prohibited to come in contact with electronic areas with hands or other tools when the machine is connected to power supply;
- 7 Touching any moving parts and laser module while the machine is running is prohibited;
- 8 Wear goggles to prevent vision damage arising from exposure to the laser spot during laser engraving operation;
- 9 It is advisable to run the machine under well ventilated condition as laser engraving may generate small amount of fume or gas;
- 10 Children under 10 years old are not allowed to run the machine without adult presence, which otherwise may lead to personal injury;
- 11 Put in place fire extinguishers in case of use, which shall be regularly checked. It is prohibited to keep the machine unattended while it is running;
- 12 Users should comply with the laws and regulations of the corresponding countries and regions where the equipment is located (used), abide by professional ethics, pay attention to safety obligations, and strictly prohibit the use of our products or equipment for any illegal purposes. Creativity will not be responsible for any violators' legal liability under any circumstance.

在雕刻或切割材料时，使用高密度激光束照射材料，使材料表面产生高温，目的是在不燃烧的情况下使材料气化。但大多数材料本质上是易燃的，可能点燃并形成明火，明火可能烧毁机器及其周围环境。请遵循以下操作原则：

- 1 请勿将本产品放置在易燃易爆物品、挥发性溶剂或高热源附近，请将本产品放置在通风、阴凉、少尘的环境内。
- 2 请勿在安装过程中使用其他产品电源线代替，请使用本产品附带的电源线。
- 3 常做产品维护，定期在断电的情况下，用干布对本产品做机身清洁，拭去灰尘和异物。
- 4 激光工作环境温度在0°C-35°C，严禁在零下温度运行，避免在潮湿环境下使用本产品，切勿在雷雨天气下使用本产品。
- 5 如长时间不使用本产品，请关闭本产品，并断开电源线。
- 6 本产品已连接电源时，请勿用手或其他工具触碰电子相关区域。
- 7 本产品运行时，请勿触碰正在运动的机械机构及激光模组。
- 8 激光雕刻过程中，请务必佩戴护目镜，避免直视激光光斑带来的视力损伤。
- 9 激光雕刻过程中可能会产生少许烟雾或气味，建议在通风良好的环境下操作。
- 10 年龄在10岁以下的儿童，请勿在没有成人监督的情况下使用本产品，以免造成人身伤害。
- 11 准备好灭火器备用，定期维护和检查灭火器。
- 12 使用者应遵守设备所在地（使用地）相应国家、地区法律法规，恪守职业道德，注意安全义务，严禁将我司的产品或设备使用在任何非法用途上。如有违反者所应承担的相关法律责任我司概不负责。

Introduction 设备简介	01-01
Parameters 设备参数	02-02
Parts List 零部件清单	03-03
Assembling 组装说明	04-07
Firmware update 固件更新	08-09
Software installation 软件安装	10-10
Software installation and use 软件介绍	11-11
Software usage 软件使用	12-14
Engraving 开始雕刻	15-19
User operation guide 用户操作流程图	20-20

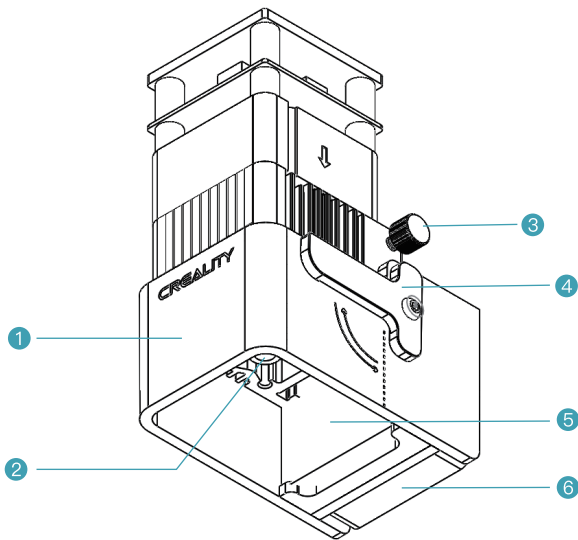

① 护目排风罩 | Eye protect exhaust hood

② 激光头 | Laser head

③ 圆柱头拧螺丝 | Cylindrical head screw

④ 定焦条 | Focusing bar

⑤ 活性炭吸烟棉 | Activated carbon smoking-adsorption cotton

⑥ 轴流风扇 | Axial fan

Product Parameters 产品参数

Name 产品名称	Laser Module
Model 型号	CV-Laser Module
Size 产品尺寸	185mm×180mm×85mm
Net Weight 产品净量	400g
Gross Weight 产品毛重	540g
Power Supply 电源要求	DC 24V
Laser Source 激光源	半导体激光器 Semiconductor laser unit
Laser wave length 激光波长	450±5nm
Laser power 光功率	1.6W
Safety Class 安全等级	Class IV (FDA 分类标准) (FDA classification standard)
Range of operating temperature 工作温度范围	0°C-35°C
Support materials 支持材料类型	Cardboard, wood, bamboo, rubber, leather, fabric, acrylic, plastic, etc. 纸板、木板、竹板、橡胶板、皮革、织物、亚克力、塑料等

3. Package Content 零部件清单

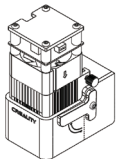

1 Laser Module
激光模组 x 1

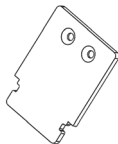

2 Laser head fixing plate
激光头固定板 x 1



3 Laser module wire
激光模组线 x 1



4 Wood plate
木板 x 2



5 Brown paper
牛皮纸 x 2

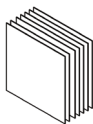

6 Color card paper
彩色卡纸 x 7

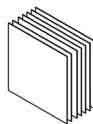

7 Color asphalt felt paper
彩色毛毡纸 x 7



8 M2 Socket head wrench
M2内六角扳手 x 1



9 Soft magnetic strip
软磁条 x 2



10 Hexagon socket
countersunk head screw
内六角沉头螺丝 x 4



11 Hexagon socket
圆柱头手拧螺丝 x 1

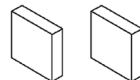

12 Activated carbon smoking-adsorption cotton
活性炭吸烟棉 x 2



13 Safety goggles
防护眼镜 x 1



14 Black cable tie
黑色尼龙扎带 x 3

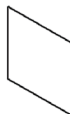

15 Dustless cloth
无尘布 x 1



16 Instruction manual
说明书 x 1

1、Take the printer Ender-3 S1 as an example: 以Ender-3 S1为例:

Remove the hotend kit 拆下喷头组件

Please make sure that before removing the hotend kit, you should firstly take off the print material from the nozzle while it is heated. Disconnect the power and allow it to cool to room temperature. Unplug the cable and loosen the four screws to remove the hotend kit.

在拆下喷头组件前,请在加热状态下将打印材料从喷嘴中取出,断电并冷却至室温后再进行以下操作:将排线拔出,拧松喷头组件旁的四颗螺丝即可将喷头组件拆下。

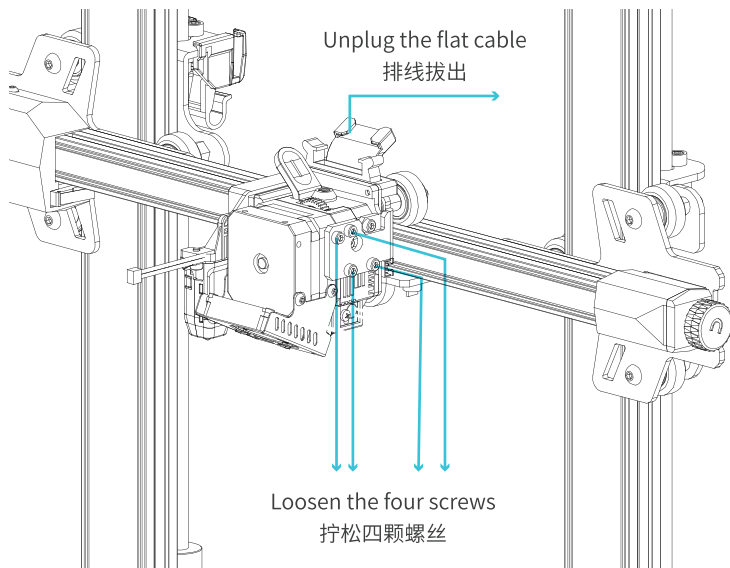

4. Assembling 组装说明

2. Install the laser head fixing plate 安装激光头固定板

Take out the laser head fixing plate and the two Hexagon socket countersunk head screw from the box, attach the fixing plate to the machine and tighten the two countersunk screws using an Allen key(clockwise).

从包装盒中取出激光头固定板、两颗沉头螺丝,将固定板安装在机器上,使用内六角扳手将两颗沉头螺丝拧紧(顺时针方向)。



- 1 Laser head fixing plate
激光头固定板 x 1



- 2 Hexagon socket countersunk
head screw
内六角沉头螺丝 x 2



- 3 M2 Socket head wrench
M2内六角扳手 x 1

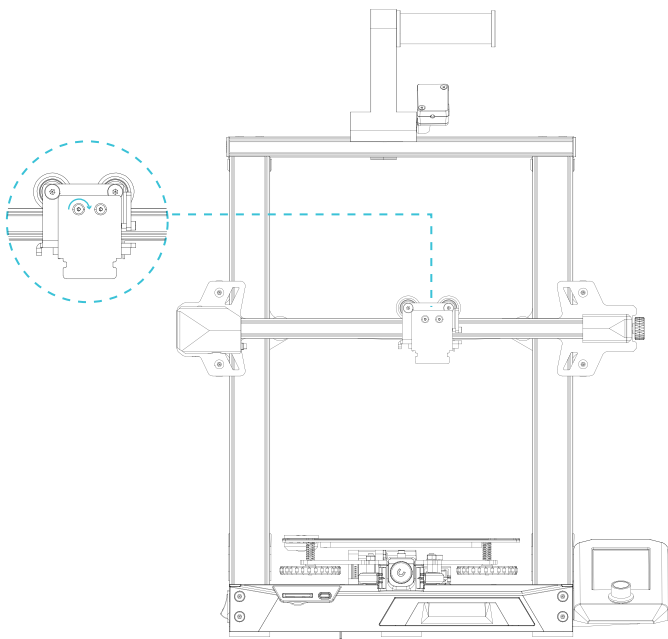

3. Installing the Laser Module 安装激光模组

Take out the Laser Module and 1 hand screw with cylindrical head from the box, attach the Laser Module to the fixing plate and tighten it using the cylindrical head hand screw (clockwise direction).

从包装盒中取出激光模组、一颗圆柱头手拧螺丝，将激光模组安装在固定板上，使用圆柱头手拧螺丝拧紧（顺时针方向）。

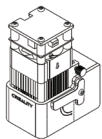

- ① Laser Module
激光模组 x 1



- ② Hexagon socket
圆柱头手拧螺丝 x 1

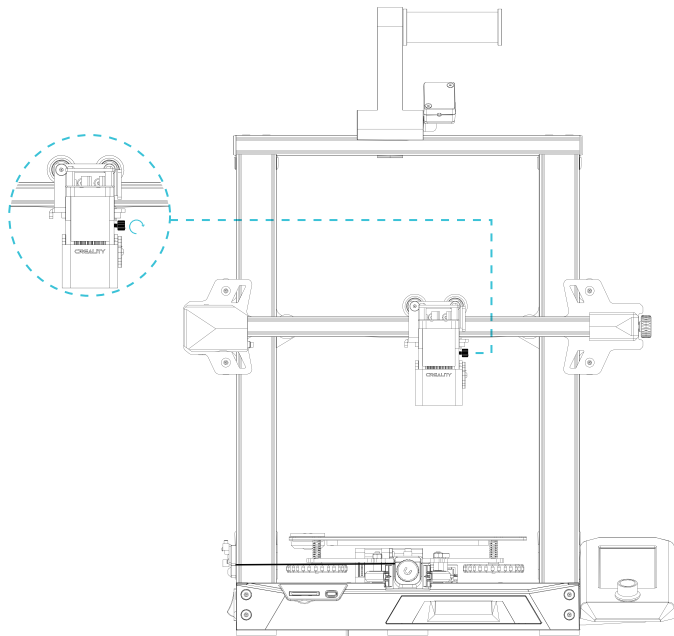

4. One side of the laser module cable plugs into the machine's expansion port and the other side into the laser head.

激光模组线的一侧插入机器的拓展接口，另一侧插入激光头。

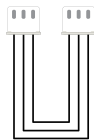

① Laser Module wire
激光模组线 x 1

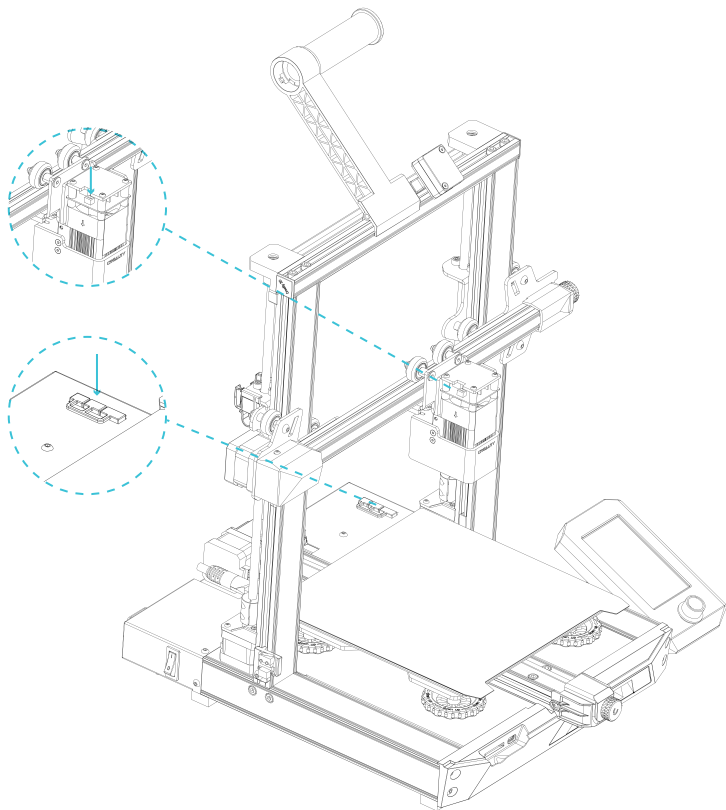

5. Firmware update 固件更新

When using the laser module on the Ender-3 S1 for the first time, please check if the motherboard firmware and the screen firmware are the applicable versions respectively. The method is as follows.

初次在Ender-3 S1上使用激光模组, 请分别检查主板固件及屏幕固件是否为适用版本。方法如下:

Connect the machine to the power supply, turn on the power switch on the side, select "Control" - "Info", the firmware version number should be V1.0.4 or above.

将机器接上电源后打开侧面的电源开关, 选择“控制”-“信息”, 固件版本号应为V1.0.4或以上。

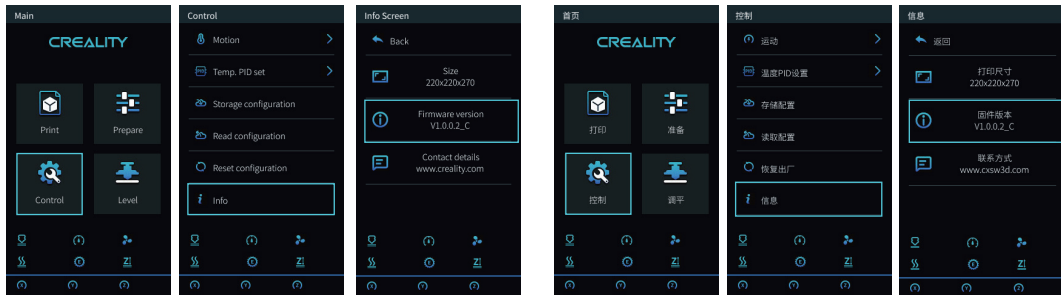

Otherwise, please download the latest version from the website link and update the firmware of motherboard and screen: <https://www.creality.com/download>→Accessory Firmware→CV-Laser Module Firmware
若固件版本号低于V1.0.4, 请从以下位置下载最新版固件压缩包: <https://www.creality.com/download>→Accessory Firmware→CV-Laser Module Firmware, 解压后参照以下方法更新固件(包括主板固件与屏幕固件):

5.1 Motherboard firmware 主板固件

5.1.1 Decompress the UPDATE.rar and copy it to SD card:

将UPDATE.rar解压后拷贝至SD卡

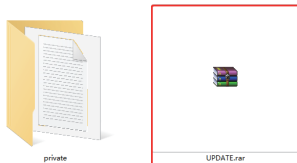

5.1.2 Insert the SD card into the machine and turn on the power to update automatically.

将SD卡插入机器, 上电即可自动更新。

5.2 Screen firmware 屏幕固件

5.2.1 Copy the private file to the TF card:

将private文件夹拷贝至TF卡：

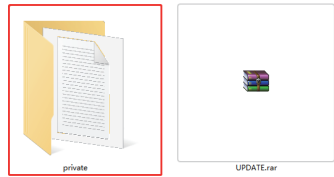

5.2.2

① Unplug the screen cable and then remove the screen from the screen holder.

将屏幕线拔出，然后把屏幕从屏幕支架取下。

② Use an Allen key to unscrew the four screws on the back of the screen and remove the lower cover of the screen.

使用内六角扳手将屏幕背后的四颗螺丝拧出，卸下屏幕下盖。

③ Insert the TF card into the TF card slot of the motherboard, plug in the screen cable and power on to update automatically.

将TF卡插入主板的TF卡槽中，插上屏幕线，上电即可自动更新。

④ After the update is complete, power off, remove the TF card, reinstall the screen and restart the machine.

更新完成后断电，将TF卡取出，将屏幕重新安装好再重启机器即可。

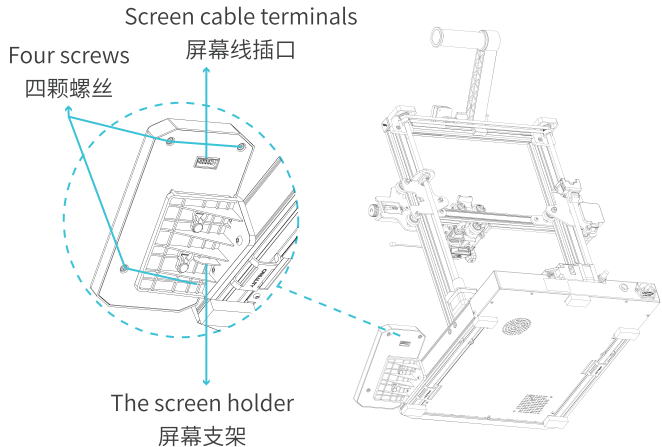

6. Software installation 软件安装

Please visit the following weblink Creality_Print : <https://www.creality.com/download>
请访问如下网址下载软件 Creality_Print : <https://www.creality.com/download>

Creality_Print supports either Windows or Mac system, please choose the right software version when download.
Creality_Print支持Windows和Mac操作系统, 下载时注意区分。

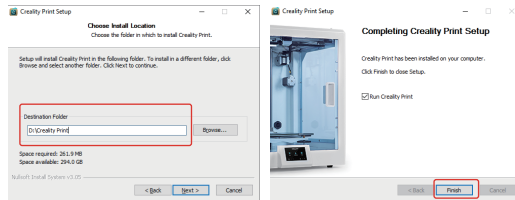
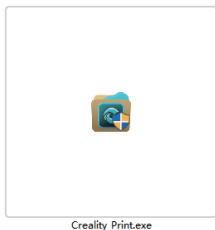

1、Double click to open the software installation package, click "Next" - "Accept".

2、Confirm the installation location of the software, click "Browse..." - "Next" - "Install" (not recommended to install on C drive) - "Finish".

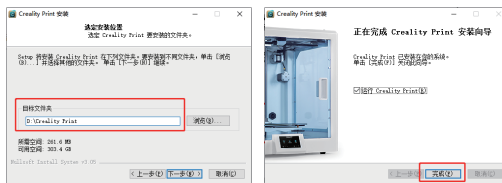
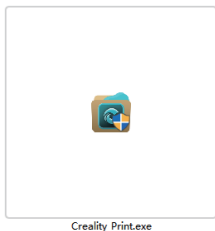

1、双击打开软件安装包, 点击“下一步”-“我接受”。

2、确认软件的安装位置, 点击“浏览...”-“下一步”-“安装”(不建议安装在C盘)-“完成”。

7. Software Intro 软件介绍

Open the Creality_Print software and click on the navigation button at the top right to see the basic features.
打开Creality_Print软件, 可点击右上方导航按钮查看软件基本功能介绍。

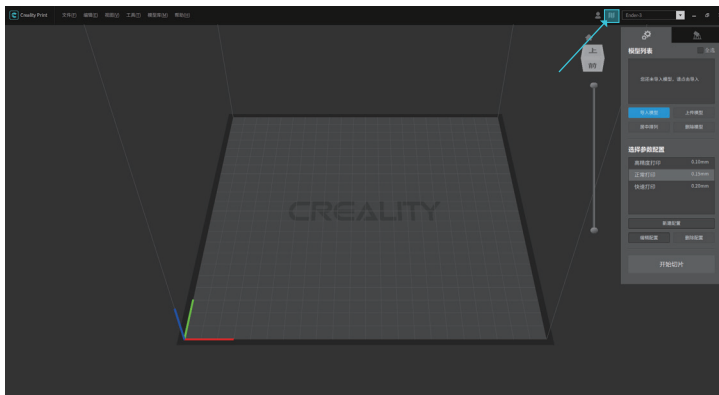
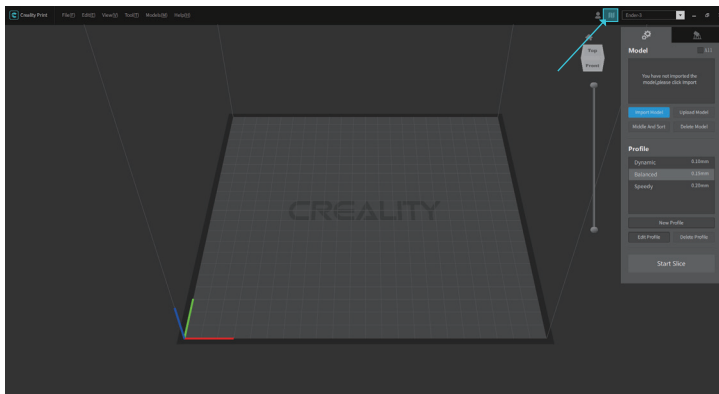

8. Software usage 软件使用

1、Add a printer 添加打印机

Take the Ender-3 S1 Laser as an example, click on the locations as shown to add your machine in turn.
以Ender-3 S1 Laser为例, 依次点击如图所示位置添加您的机器。

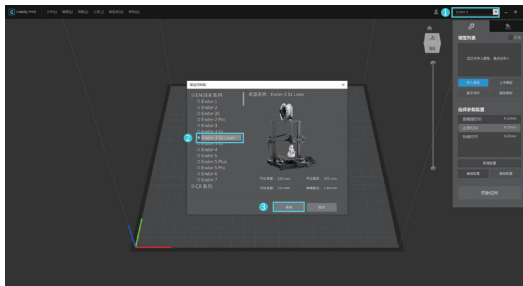
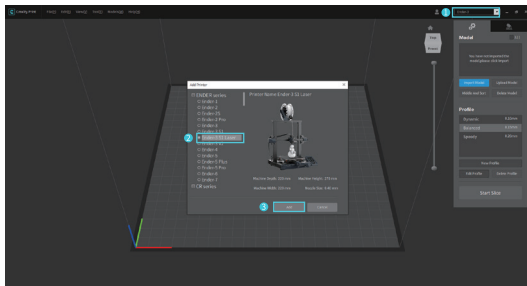

2、Make sure the current status is "Laser".

确保当前状态为激光雕刻模式。

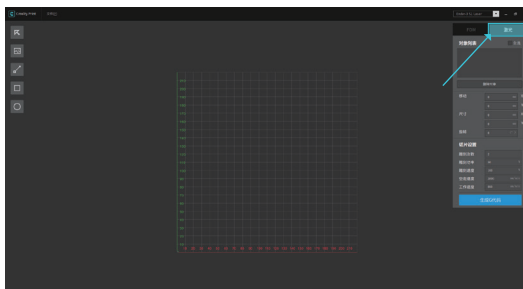
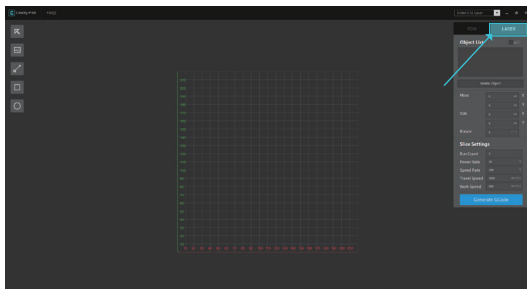

3. Click on the "Picture" button on the left and find the image file you need to engrave. Open to import the picture into the CreativityPrint software.

点击左侧“图片”按钮，找到需要雕刻的图像文件。点击打开，把图像导入到 CreativityPrint 软件中。

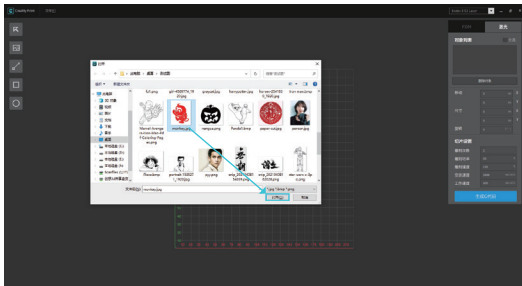
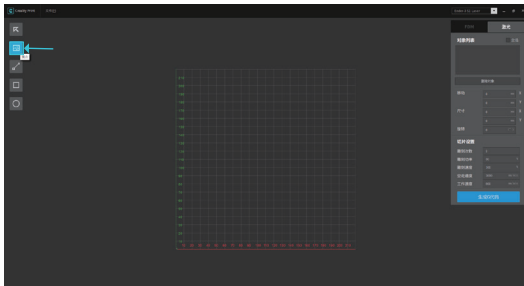
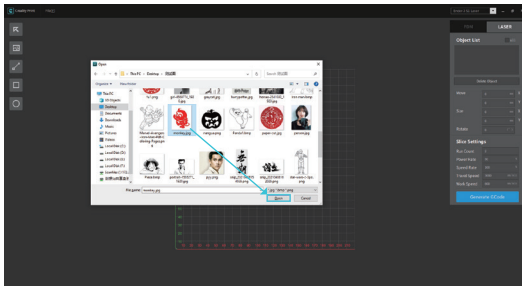
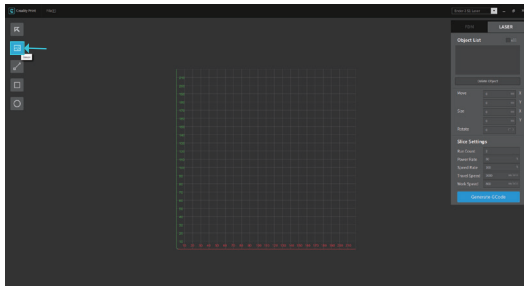

4. Adjust the position, size, rotation angle and other parameters of the file in the right-hand console, setting the processing mode and working parameters, finally preview the processing effect of it.

在右侧控制台中调整图像文件的位置、尺寸、旋转角度等参数，并设置图像的处理模式、工作参数等，最后对图像的加工效果进行预览。

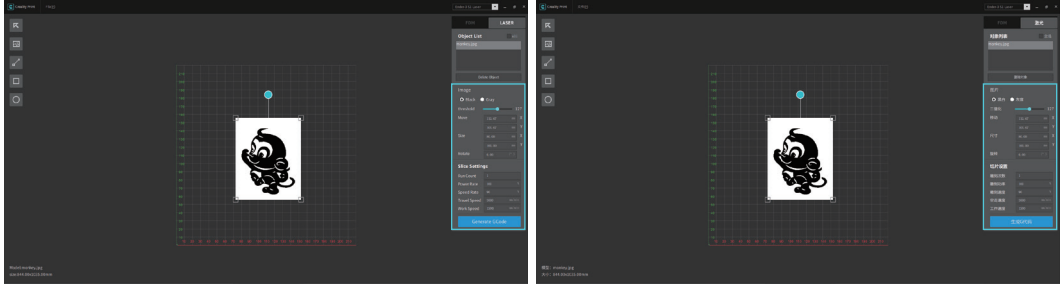

5. Finally, click on "Generate G-Code" to save the engraving file on the SD card.

最后点击“生成G代码”，将雕刻文件保存在SD卡中。

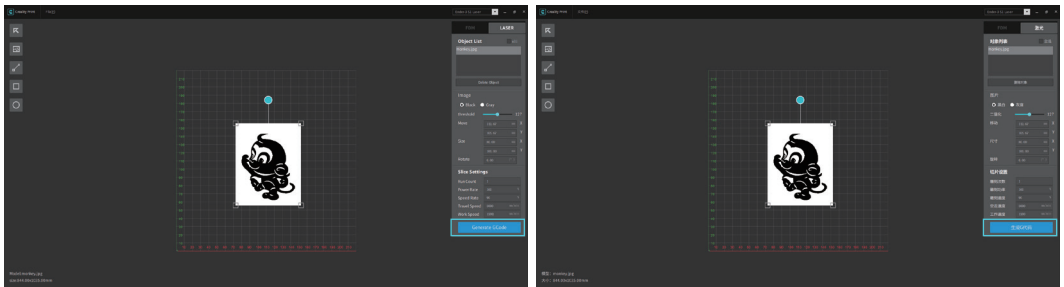

9. Engraving 开始雕刻

- 1、Insert the SD card into the machine and turn on the power switch on the side.
将SD卡插入机器，接上电源后打开侧面的电源开关。

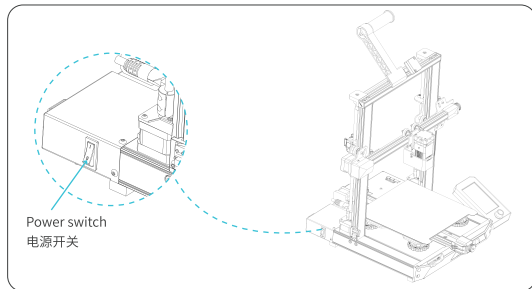

- 2、After the machine is switched on, if you are using it for the first time, please select laser engrave.
机器开机后，若首次使用，请选择激光雕刻。

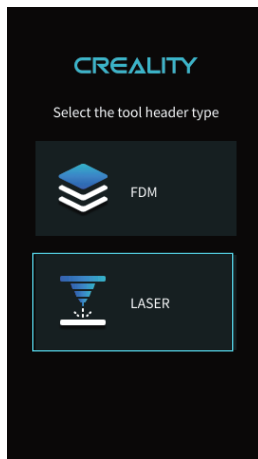

To switch from fusing to laser engrave, select "Control" - "Switched Laser engraving".

若要从熔积打印切换成激光雕刻，请选择“控制”-“切换激光雕刻”。

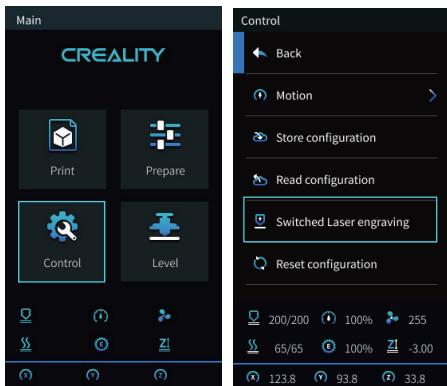

The software pops up the following prompt box. Please ensure that the laser module is installed correctly (note that the laser module must be installed and removed only when the power is off) and select "Confirm".

此时软件弹出以下提示框，确保激光模组安装无误后（注意激光模组必须在断电状态下才能进行安装与拆卸），选择“确定”。

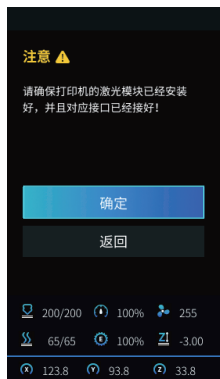
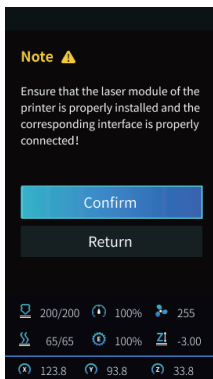

3. Please place the engraving material under the laser head, counter-clockwise push the fixed focus bar, adjust the laser focus to the appropriate value through the knob (different thickness of the material corresponding to different values), until the focusing bar touches the engraved material surface when natural vertical down. Finally, clockwise push the focusing bar until it is attached by the magnet, then select "Finish".

将雕刻材料放至激光头下，逆时针拨动定焦条，通过旋钮调整激光焦距至合适数值（不同厚度的材料所对应数值不同），直至定焦条自然垂直向下时与雕刻材料表面互相接触。最后顺时针拨动定焦条直至被磁铁吸住，选择完成。

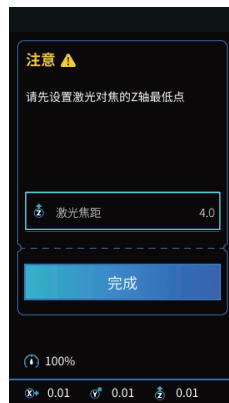
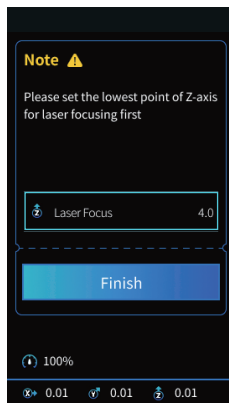

4. Return to the main interface, select "Auto Home", wait for the machine back to zero completed.

返回软件主界面，选择“回零”，等待机器回零完成。

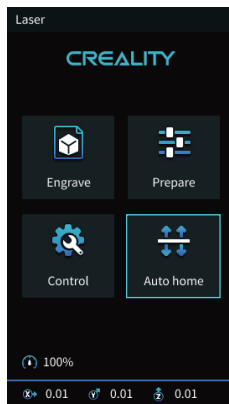

5. Select “Engrave” and press the knob to confirm.
 选择“雕刻”，选择需要雕刻的文件，按下旋钮确定。

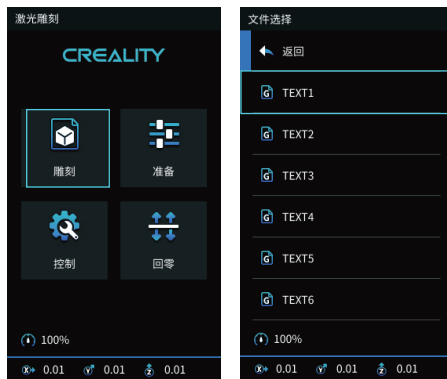
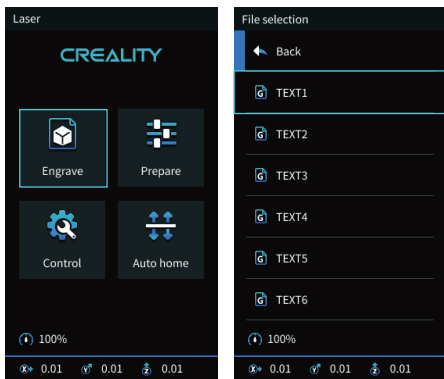

Select "Run Range", the laser head will move repeatedly around the maximum X and Y edges. You can adjust the engraving material to the right position.

选择“跑边框”，此时激光头会围绕所加工图片的最大 X、Y 边缘重复运动，此时可以调整材料至合适位置。

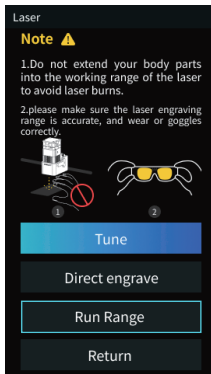

6. Press the “Directly Engrave” to start engraving.
调整完材料位置后,选择“直接雕刻”,机器开始雕刻。

If you need to pause during engraving, please select "Pause" and select "Print" again for the machine to continue. If you need to cancel the engraving task, please select "Stop".

雕刻途中如果需要暂停雕刻,请选择“暂停”,再次选择“打印”机器可继续工作;如果需要取消雕刻任务,请选择“停止”。



Caution.

When engraving or cutting thin objects (e.g. paper), the laser may penetrate the object and leave marks. It is recommended to put a flat object which laser cannot penetrate, such as aluminium or stainless steel plates, before you put the engraving material.

需要注意:

雕刻或切割较薄的物体(如纸张)时,激光可能会穿透物体并在工作平面上留下痕迹。建议在使用本产品时,在工作平面上放置激光无法穿透的平面物体如铝合金或不锈钢板,然后再放置加工材料。

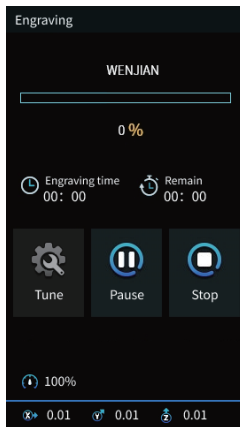
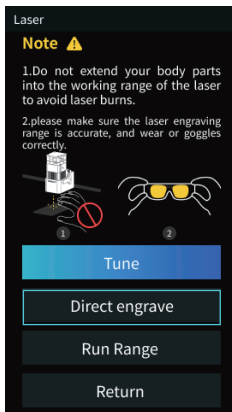

10. User operation guide 用户操作流程图

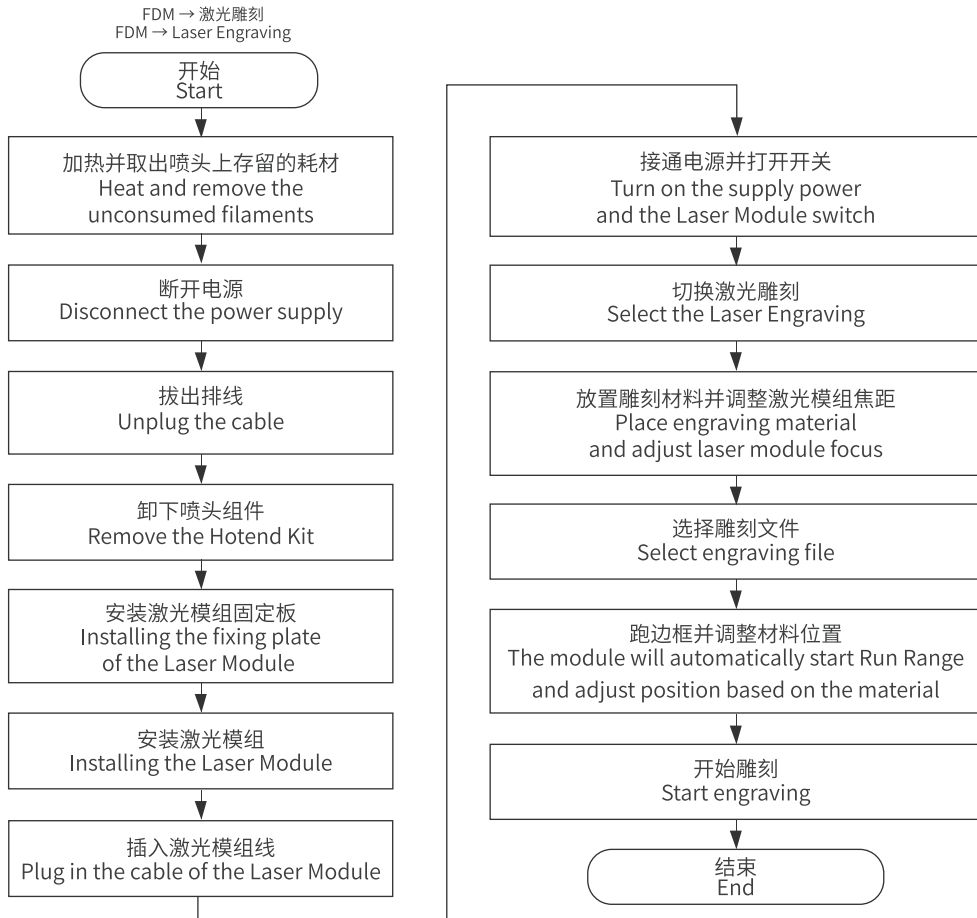

激光雕刻 → FDM
Laser Engraving → FDM

开始
Start

断开电源
Turn off the power

拔出激光模组线
Unplug the laser module cable

卸下激光模组
Removing the Laser Module

卸下激光模组固定板
Removing the fixing plate
of the Laser Module

安装喷嘴组件
Installing the nozzle kit

插入排线
Plug in the cable

接通电源并打开开关
Turn on the supply power and
the Laser Module switch

切换熔积打印
Select the FDM

调平
Leveling

选择打印文件并开始打印
Select the print file and start printing

结束
End

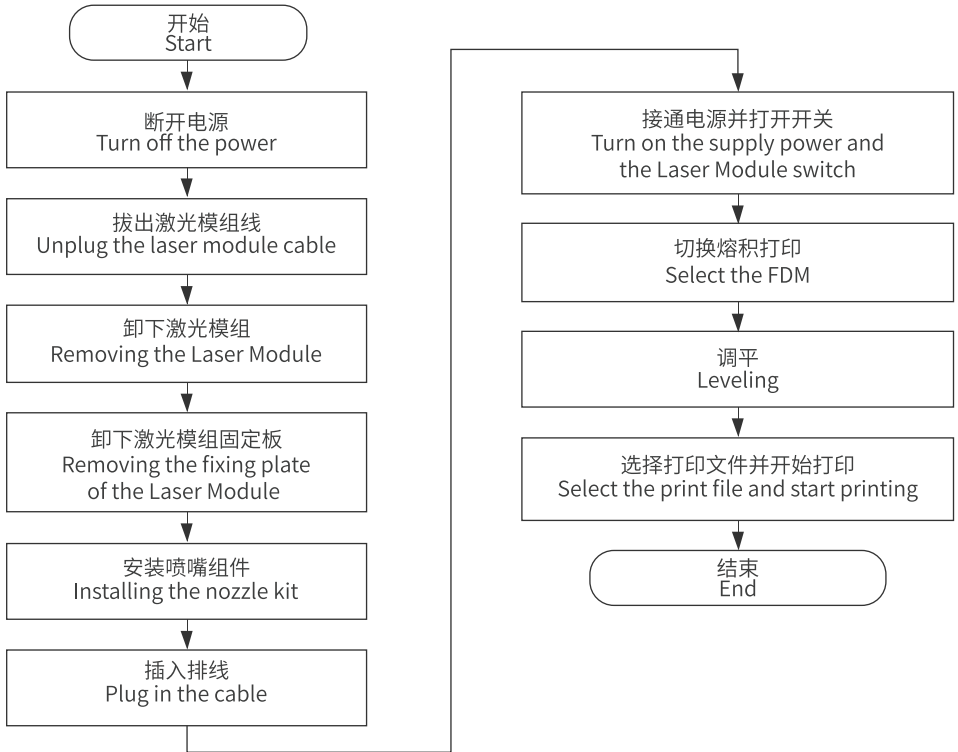

Due to the differences between models, product images and description only for reference purpose, please see the subject produce. The final explanation rights shall be reserved by ShenZhen Creality 3D Technogy Co., Ltd.

因每款机型不同, 实物与图可能有所差异, 请以实物为准, 最终解释权归深圳市创想三维科技股份有限公司所有。



SHENZHEN CREALITY 3D TEC

18F, JinXiuHongDu Building, Meilong Blvd., Longhua Dist., Shenzhen,
China 518131

Official Website: www.creality.com

Tel: +86 755-8523 4565

E-mail: info@creality.com cs@creality.com



深圳市创想三维科技股份有限公司

深圳市龙华区民治街道新牛社区梅龙大道锦绣鸿都大厦18F

公司网站: www.cxsw3d.com

服务热线: 400 6133 882

0755-8523 4565