



User Manual

Please read all the information
before you hit the road with your board.

Contents

Read Before Riding..... 1

Warnings..... 2

Board Diagram..... 3

Remote Diagram..... 4

Charging the Board and the Remote..... 5

Connecting (Pre-paired with Board)..... 5

Pre-Ride Checklist..... 6

Riding Stance..... 7

Riding the LycaonBoard..... 8

Remote Warning Instruction..... 10

Remote Control Specification..... 12

Technical Parameters of Lycaon GR..... 12

Packing List..... 15

Proper Use of the Board..... 16

Limited Warranty..... 16

For all Return and Warranty Shipping..... 16

Read Before Riding

Always wear a helmet. Other safety gear such as gloves, pads, closed-toe shoes, long sleeves, and long pants are strongly advised.

Be aware of other cars and vehicles, as they can kill. Always ride defensively when in the presence of other vehicles. Be aware of local laws that govern proper usage of your board on public roads, bike paths, sidewalks, or other places you may ride.

Braking downhill on a full battery can cause a board shutdown. Internal circuitry will allow for some braking on a downhill at full charge, but this braking is limited. To avoid this be sure to ride on flats or uphill to drain the battery before attempting a downhill after a full charge.

Your board can lose power and brakes at any moment due to radio interference, a dead remote battery, downhill overcharging on a full battery, and other factors. Only ride your board at speeds and on hills where you'd be comfortable without power and brakes.

Acceleration in Pro mode is rapid and may be dangerous.

Hills and high speed can be very dangerous. Be sure to start slow and remain extra careful in these conditions, even if you are an experienced rider.

Warnings

ONLY CHARGE USING A LYCAONBOARD CHARGER. OTHER CHARGERS MAY POSE RISK OF FIRE.

Always wear a helmet when riding.

Never ride in the water, over wet surfaces, in the rain, on slippery or uneven surfaces, steep hills, or in traffic. Avoid cracks, train tracks, gravel, rocks, or any obstacles that could cause loss of traction. Avoid riding at night, areas with poor visibility, and narrow spaces for any safety risk.

When you ride a LycaonBoard Electric Skateboard you risk death or serious injury from loss of control, collisions, and falls. You must read and follow all warnings and instructions in this manual.

Do not ride the LycaonBoard Electric Skateboard in environments, on inclines, or at speeds where you would not be safely in control of an unpowered skateboard. In the event of wireless interference or battery fault, you may need to rely on skating techniques like foot braking or sliding to a stop. Riding in wet conditions or through puddles may damage the board's electronics and cause the board to lose power or stop suddenly, causing a risk of loss of control or falls. Damage to the board due to water exposure is not covered under warranty. Keep your fingers, hair, and clothing away from belts, motors, wheels and all moving parts. Do not open or tamper with electronics housings.

Electric shock is possible and this also voids the warranty.

Board Diagram

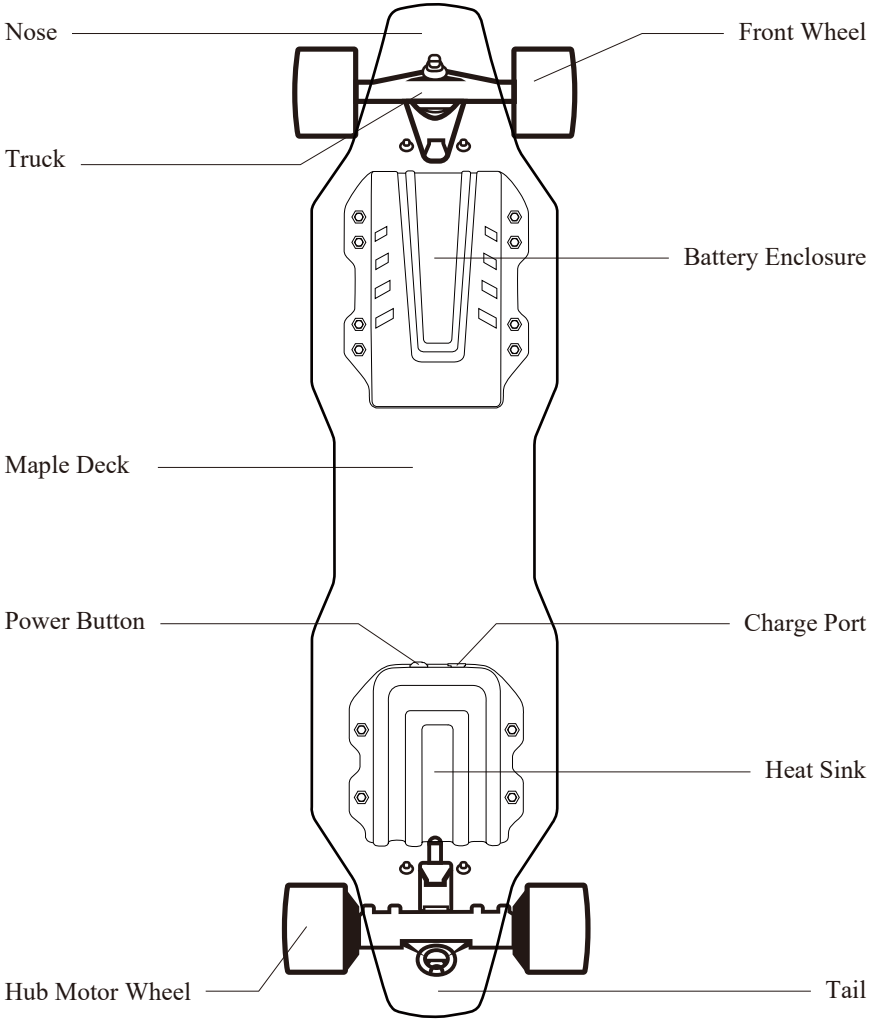

Remote Diagram

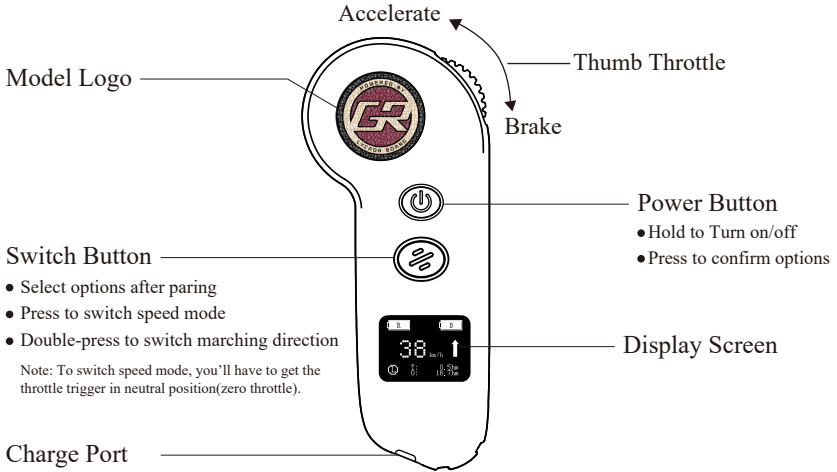

Battery Status of The Remote/ Board

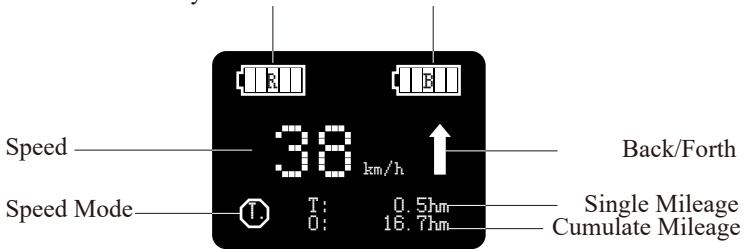

- ① Speed Mode: Low (L)
Medium (M)
High (H)
Pro Mode (P)

- ② Brake Intensity changes with speed modes

Charging the Board and the Remote



① Charging the board: Connect the charger to the skateboard, it will enter into charging state automatically with the red indicator light on.

When properly charging the light on the charger will turn red. When charging is complete the light will turn green.

② Charging the remote: When charging the remote control, the remote vibrates shortly once. The screen displays the charging progress in real time.

Note: Either the remote or the board could not be operated or would not work in the charging state.

Connecting (Pre-paired with Board)

1. Keep the remote and the board powered off.
2. Hold the power button of the board and that of the remote at the same time for about 5 seconds.
3. The remote control will display a successful pairing prompt with two short vibration and one long vibration when pairing is successful.
4. Speed, mileage unit and wheels diameter shall be selected when the remote got paired with the board. Press Switch Button  to switch options, and press Power Button  to confirm. Re-pairing remote allows to reset all the options.
5. After wheels diameter option is selected, the remote will enter into main function interface.

Pre-Ride Checklist

- Always wear a helmet. Other protective equipment such as gloves, pads, closed-toe shoes, long sleeves, and long pants are recommended.
- Ride in an open, flat area without foot or car traffic for your first rides. Also make sure the speed mode and marching direction are set to your responsive way.
- Read through the warnings on the first two pages of this manual.
- Avoid environments that can cause loss of control including loose gravel, water, hills, cracks, train tracks, traffic, low light, or poor visibility.
- Regularly check and tighten all hardware.

⚠ AVOID THESE THINGS THAT CAN CAUSE SLIPPING:

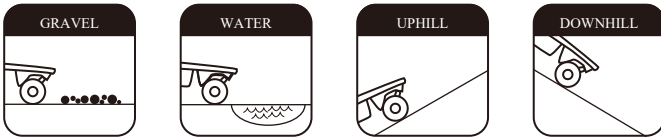

⚠ AVOID THESE THINGS THAT CAN CAUSE TRIPPING:

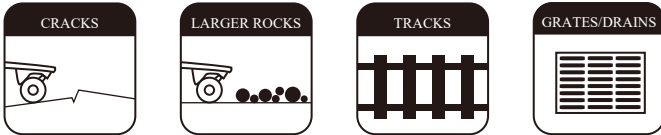

⚠ AVOID THESE THINGS THAT CAN CAUSE COLLISIONS:



Riding Stance

Riding "Regular" means you stand with your left foot forward, towards the nose of the board. Riding "Goofy" means you stand with your right foot forward. How do you know which one you are? Think about a tug-of-war - whichever foot you would put forward when competing in a tug of war to brace yourself, that is the foot you should put forward when riding. Test and see what works best for you.

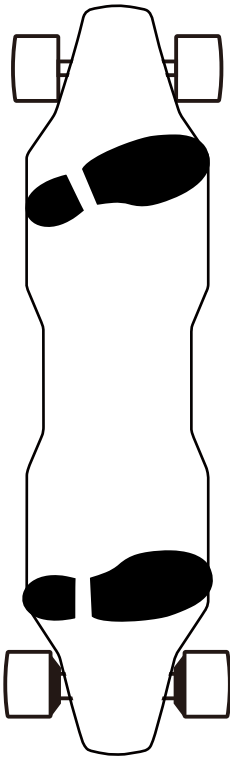

Regular Stance

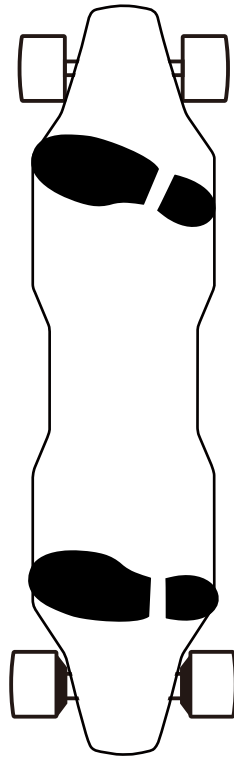

Goofy Stance

Riding the LycaonBoard

Accelerating

First, bend your knees and shift your weight forward towards the board's nose. Gently extend your thumb to push the Thumb Throttle away from you until the motors begin to engage. The further you roll the Thumb Throttle forward, the faster Lycaon Board will go. At any time you can release the ThumbThrottle to coast or roll it backwards to brake.

Braking

When you are ready to brake make sure to bend your knees and shift your weight to the rear of the deck. Gently roll the Thumb Throttle downwards until you feel the board's motors begin to actively slow the board down. For additional braking power roll the Thumb Throttle downward at a faster rate, but be sure your stance is prepared so you don't lose your balance and have to step off the board.

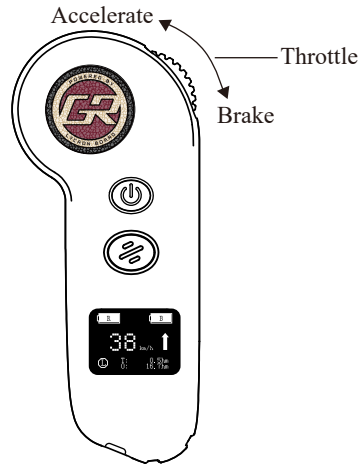

Lycaon GR electric skateboard adopts the regenerative braking system. Riding the fully charged board downhill may cause over current damage to the board.



Coasting

To coast, simply release the Thumb Throttle. This will cut power to the motors though you still will feel added friction from the drive train.

Reverse

To switch the board into Reverse, double-press the Switch Button , and you'll see the \uparrow/\downarrow arrow switching directions on the display screen. Now, roll the Thumb Throttle up to go in reverse and down to brake (slowing down your reverse speed). The board must be stationary to change between forward and reverse. If you double-press the Switch Button  while moving, the board will be unresponsive to Remote input until either the board comes to a stop or the Switch Button is pressed again to re-engage power in the forward direction.

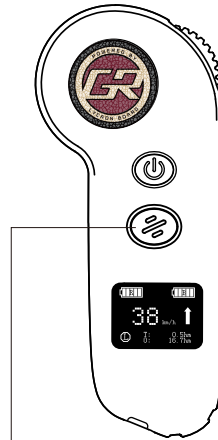

Double-press to switch marching direction

Remote Warning Instruction

1) Battery low voltage warning

When the battery of remote control is less than 10% (enough for 30 minutes at most), the screen of remote control indicates that the power is less than 10%, accompanied with a double long vibration. When the battery is only 5% (enough for 15 minutes). The remote control reminds that the power is less than 5%, accompanied with a double long vibration. When the battery is lower than safe voltage (3.4V) and connected with skateboard and the skateboard stops, the remote control will have a short vibration and power off automatically.

When the battery of skateboard is lower than 25%, the screen of remote control indicates the battery is lower than 25%, accompanied with a double long vibration. When the battery of skateboard is lower than 10%, the remote control indicates that the battery is lower than 10%, accompanied with a double long vibration. When the voltage is lower than safe voltage, the power output will be turned off and you should brake immediately at this time.

Note: When the battery of remote control or skateboard starts to remind for the second time, you'd better stop using it and charge related devices to avoid damage lithium battery due to over discharge.

2) Signal loss warning

When the signal is lost suddenly, the screen of the remote control indicates disconnection, accompanied with a short vibration. If the skateboard is accelerating, the acceleration will first stop slowly, then automatically brake slowly. If the skateboard is not accelerating, it will brake slowly. If the signal is lost, the remote control will search the device of skateboard. If it succeeds in searching and reconnecting, the remote control will have a short vibration, the slow brake will be cancelled and return to normal operation.

3) Lock-up warning

When the motor is lock-up or completely struck, the remote control will have continuously and intermittently short vibration, and the screen of remote control indicates motor lock-up. If that happens, the user should stop using skateboard and check the motor to see if there is foreign matter struck in it, remove the foreign matter before operating the skateboard again.

4) Overheating warning

When the operating temperature of motor is higher than 100°C or lower than 0°C, the remote control vibrates once and the screen indicates overheat and the motor will stop working.

Note: The user should pay attention to the temperature of motor. When the motor temperature is too high, the user should stop using it and wait until the temperature drops.

5) Overcurrent warning

When the operating current of motor exceeds allowed value, the screen of remote control indicates overcurrent and the motor will stop working.

Note: Turn off the skateboard and turn it on again, and use it only when the current returns to normal.

Remote Control Specification

| | |
|---------------------------------|-----------------|
| Battery Voltage/Capacity | 3.7V/200MAH |
| Charging Port | USB Type-C |
| Charging Time | 0.5H |
| Communication Mode | 2.4G |
| Remote Control Distance | 40m (Open area) |
| Weight | 60g |

Technical Parameters of Lycaon GR

| Product Parameter | Model | Double-drive 36V Skateboard |
|--------------------------|---|---|
| Product Specification | Board dimension (subject to the real product) | 940MM*230MM* 12.5MM Length*Width*Thickness |
| | Wheel base | 780MM |
| | Total weight | 8.6kg |
| | Ground clearance of board surface | 106MM |
| | Climbing Angle | 20-30% |
| | Board material and thickness | Board material: 8-layer Canadian maple board thickness: 12.5MM |
| | Bridge material and dimension | 45° 7 inches, high-strength aluminum-magnesium alloy |
| | Abrasive paper | Air-permeable abrasion-proof silicon carbide paper |
| | Shock absorber | High-elasticity SHR83A PU shock absorber |

| | | |
|---------------------|---|---|
| Product Performance | Max.load | 100kg |
| | Top Speed in 4 Speed Modes | L (Low) : 12 mph / 20 kph |
| | | M(Medium) : 18 mph / 30 kph |
| | | H(High) : 25 mph / 40 kph |
| | | Pro (Top Speed): 25 mph / 40 kph(Instantaneous Acceleration) |
| Range: | 15-25 miles/ 24-40 km(Depending on riding style, weight, terrain and weather) | |
| Battery Parameters | Battery type | 18650 Li-ion Battery |
| | Standard voltage | 36V |
| | Battery capacity | 10S3P 7.5Ah 270Wh |
| Motor Parameters | Motor type | Double-drive brushless hub motor 90*54mm SHR83A PU rubber coating |
| | Rated output power | 480W*2 |
| | Torque | 6Nm |
| | Max. instantaneous power | 1200W |
| | Rated voltage | 36v |
| PU wheel | Type | High-elasticity PU wheel (black) |
| | Specification | 90*54mm SHR83A rubber coating |
| | Bearing | HCH 608RS ABEC-7 |

| | | |
|---------------------|----------------------------|--|
| Charger Parameters | Input voltage | AC100-240v 50/60Hz |
| | Output voltage and current | DC42V 2.5A |
| | Charging time | 3-4 hours |
| Bake Method | Electronic brake | EBS |
| Protection Measures | Intelligent BMS | Over-voltage / Under-voltage / Over-current / Short circuit / Overheat / Auto sleep, wake-up |
| -- | -- | Charge Temperature Range: 10-40°C Operating Temperature Range: 0-40°C |

Packing List

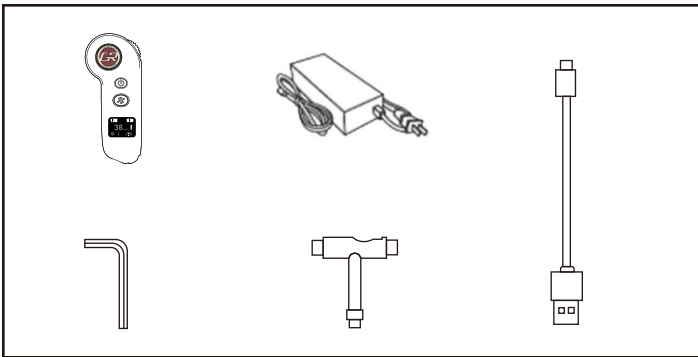
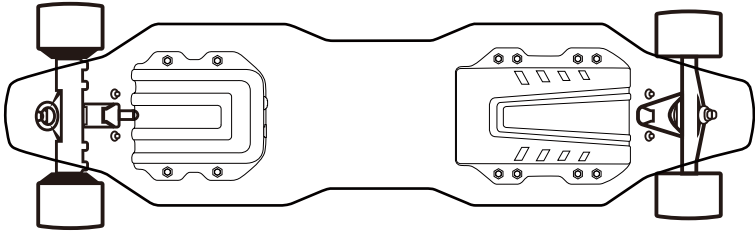

- Your new Lycaon GR Board
- Wireless Remote Controller
- Charger
- Charging Adapter
- T Tool
- Allen Wrench

Proper Use of the Board:

Riding off curbs, doing jumps/hops, throwing the front down to the pavement, and subjecting the board to other high-impact events may damage internal electronic components over time. Any amount of water has the potential to damage the board's electronics, and water damage is not covered under warranty. We highly recommend that you regularly inspect and maintain the board before riding.

For more detailed maintenance tips, please visit our website:

<https://lycaonboard.com/blogs/maintenance>

Limited Warranty:

This board is covered by a 240 day manufacturer's warranty that covers defects in workmanship and material. This does not cover damage caused by abuse, misuse, negligence, accident, or riding in water.

LycaonBoard offers warranty against defects in workmanship and/or materials to the original purchaser. If there are any manufacturing defects, we are responsible for troubleshooting, and offering free repair service or sending replacement parts to fix issues, not including issues caused by any personal behaviors.

For all Return and Warranty Shipping:

Please keep your shipping box. The warranty does not include damage from shipping in insufficient packaging.

For more detailed warranty policy, please visit our website:

<https://lycaonboard.com/pages/warranty>

