

# Pendant Light Installation

## Tools Required:

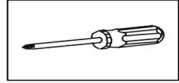
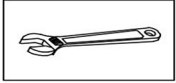

Adjustable Wrench

Philips Screwdriver

## Before Installation

1. Please read these instructions before assembling or installing the product. **NOTE:** Installation by a licensed electrician is recommended.
2. Take out the fixture and the mounting package and make sure all parts are included. If any part is missing or damaged, please contact us.
3. All parts must be used as indicated in these instructions. Do not substitute any parts, leave parts out, or use any parts that are worn out or broken.
4. Do not disassemble the main body, as it has been installed & commissioned correctly & precisely before leaving the factory.
5. **IMPORTANT:** Turn off the main power at the circuit breaker and place the wall switch or pull chain in the "OFF" position.
6. Do not use bulbs with wattage greater than specified on this fixture.

## Parts List

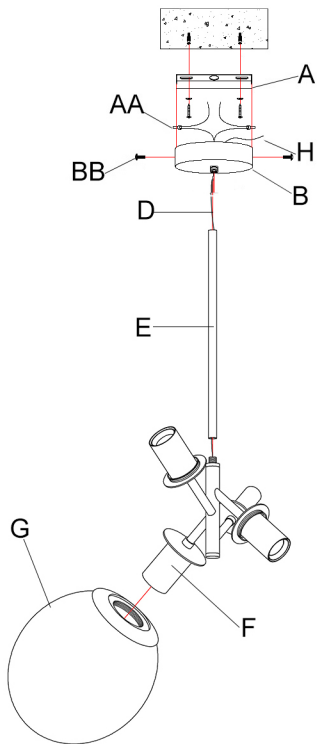

Part	Name	Quantity
A	mounting strap	1
B	canopy	1
D	main wire	1
E	long hanging rod	1
F	lamp holder	4
G	light shade	4
H	ground wire	1
AA	wire connectors	2
BB	Flat head screw	2

## Installation Guide



1. Shut off power before installation. Fix the mounting strap (A) to the ceiling.

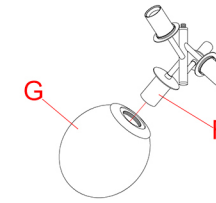

2. Install light bulbs (not included) to the lamp holders (F). And screw light shades (G) to the lamp holders (F).

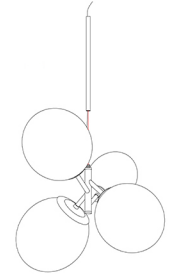

3. Feed the main wire through the hanging rod (E). Then, screw one end of long hanging rod (E) to the light fixture and the other end to the short hanging rod

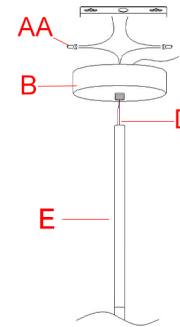

4. Feed the main wire (D) through the canopy (B). Install the short hanging rod (E) into the canopy (B). Connect the wires with wire connectors (AA) to the corresponding wires in the ceiling.

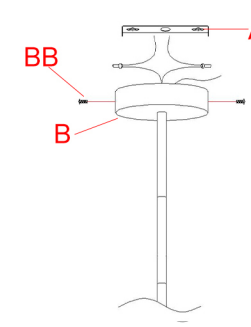

5. Attach the canopy (B) to the mounting strap (A) and fix with cap nuts (BB).

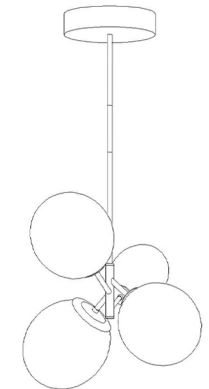

6. Turn on the power and test.

## Troubleshooting

Problem	Possible Cause	Corrective Action
Fixture does not light.	<ol style="list-style-type: none"> <li>1. Fixture may be wired incorrectly.</li> <li>2. Worn or broken bulb.</li> <li>3. Lamp socket or LED transformer (if applicable) may go bad.</li> </ol>	<ol style="list-style-type: none"> <li>1. Check wiring.</li> <li>2. Replace bulb.</li> <li>3. Replace lamp socket or LED transformer (if applicable).</li> </ol>
Light bulb flickers.	<ol style="list-style-type: none"> <li>1. Switch Contacts are bad.</li> <li>2. Wire connections are loose.</li> <li>3. Light bulb socket may go bad.</li> </ol>	<ol style="list-style-type: none"> <li>1. Replace the switch.</li> <li>2. Check wire connections.</li> <li>3. Replace the socket.</li> </ol>