

## Chandelier Installation

### INSTALLATION MANUAL Tools You Will Need:



Adjustable wrench



Hexagon wrench



Phillips Screwdriver

### Before the Installation

1. Do not throw away packing materials until assembly is complete for small parts may come loose inside the carton during shipment. If parts are missing, please contact us.
2. Assemble this item on a soft surface, such as carpet to protect the finish.
3. Proper assembly of this item requires 2 people.
4. Periodically check to ensure that all connections are tight.
5. It is recommended that installation of the product be done by a qualified licensed plumber.

### Care and Cleaning

1. To protect the finish, avoid use chemicals and household cleaners.
2. All hot serving dishes should be placed on a pad.
3. Any liquid spilled onto the top should be cleaned up immediately with a damp cloth.

# Parts List

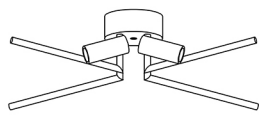
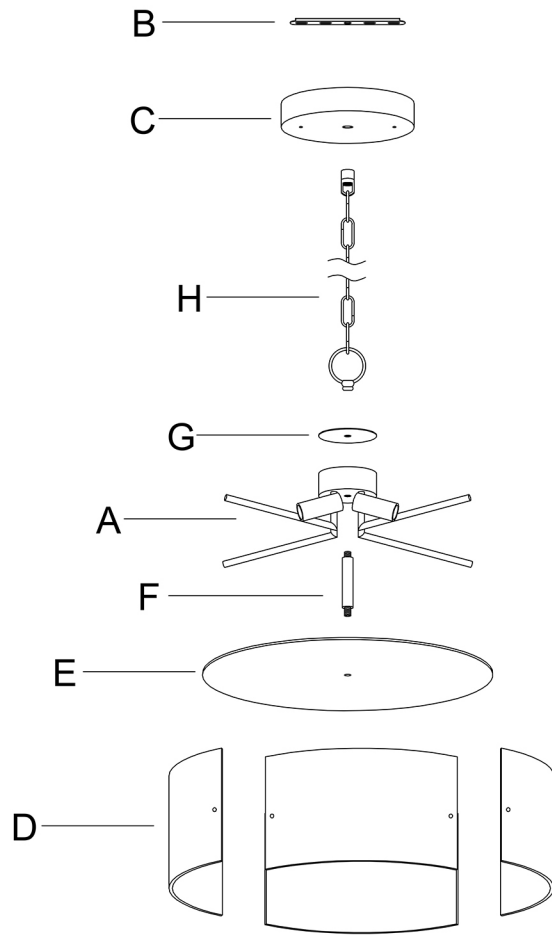

Ax1



Bx1



Cx1

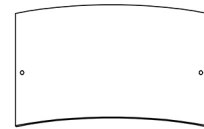

Dx4

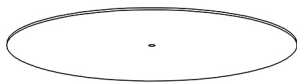

Ex1



Fx1



Gx1



Hx1



Ix2



Jx1



Kx1



Lx2



Mx2



Nx8



Ox8



Px1



Qx1



Rx1



Sx2



Tx2



Ux2







Vx2





Wx2

# Step 1

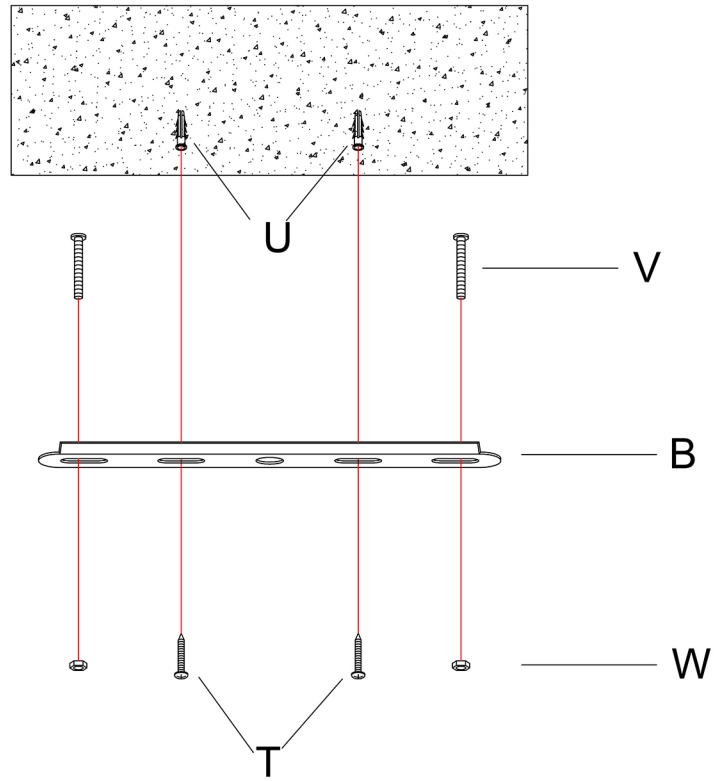
- T  x2
- U  x2
- V  x2
- W  x2



# Step 2

- J  x1
- M  x1

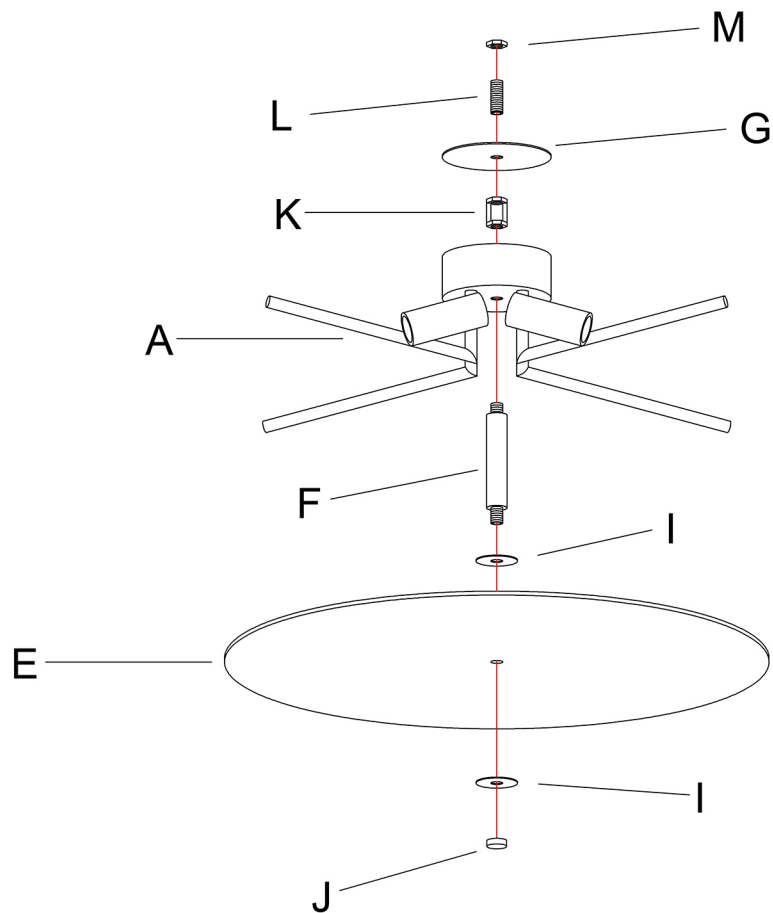

### Step 3

P.4/5

N  x8

O  x8

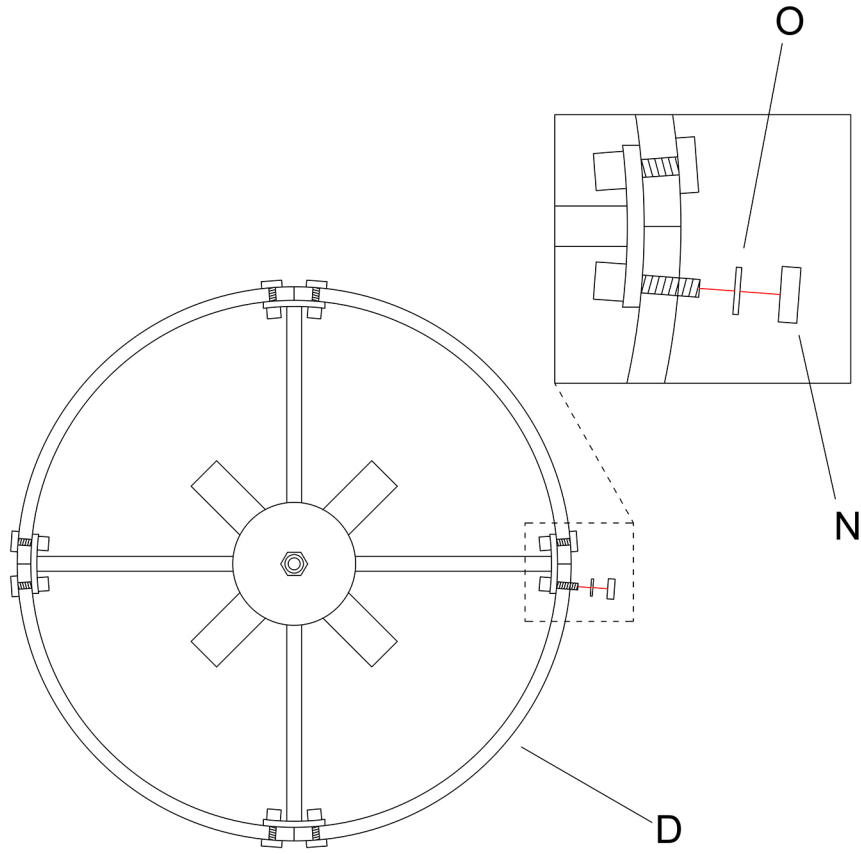

### Step 4

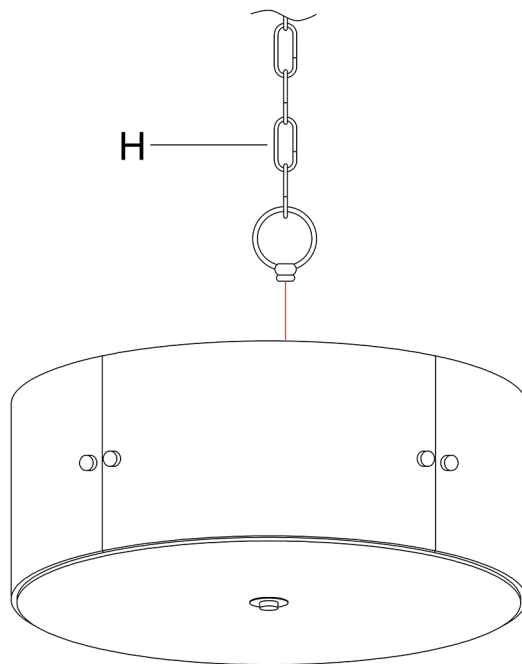

# Step 5

M  x1

P  x1

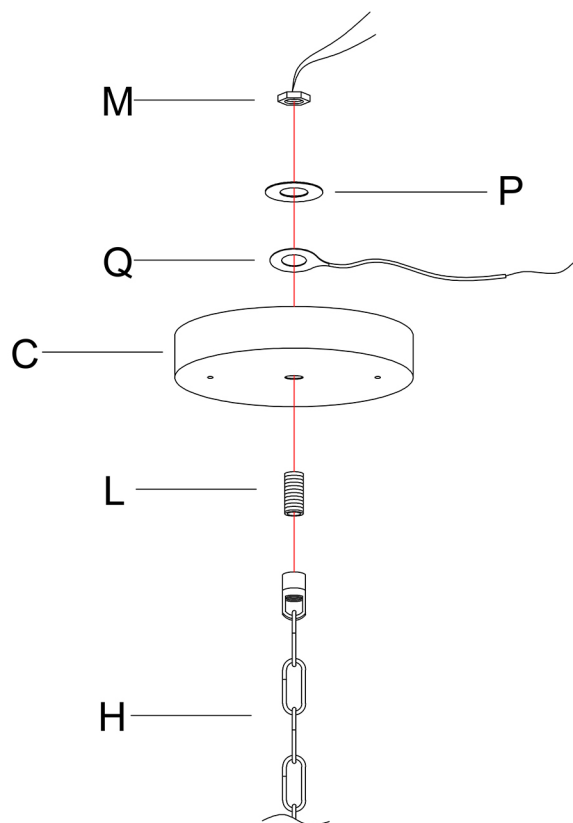

# Step 6

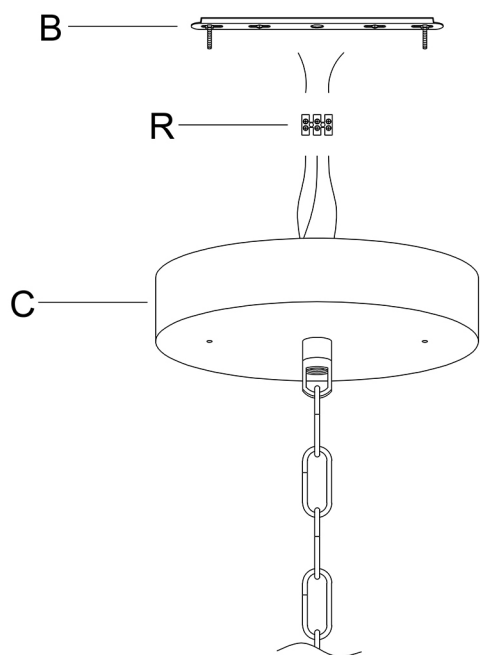

# Step 7

S  x2

